

## CONSTRUCTION

- Top constructed of 1 1/8" particleboard with thermo-fused melamine surface on top and bottom
- Thermally fused 3mm PVC edge banding
- Pre-drilled holes for easy leg assembly
- Four 16-gauge steel legs mounted on a 12-gauge steel plate, fully coated with a durable powder coat finish
- Lower adjustable leg constructed of 16-gauge steel with a powder coat finish, tapped at 1" intervals for adjustment from (12" - 15") leg heights
- 16-gauge 1" square tubular steel stretcher attached to all tables 54" in length or longer
- Nickel-plated adjustable height nylon glides

## FINISHES

### LAMINATES Available with matching or colored edge band

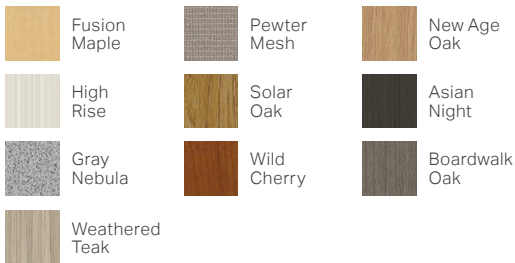

### DRY ERASE LAMINATES Available with colored edge band

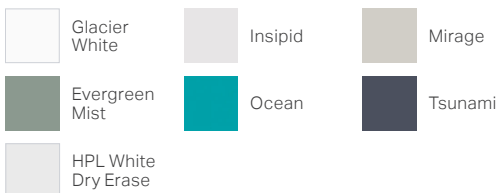

### OPTIONAL EDGE BAND COLORS

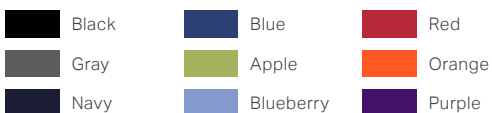

### METAL LEG COLOR



## WARRANTY

10 Year Limited

## CERTIFICATIONS

Worksurfaces are UL Greenguard Gold certified

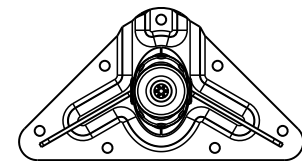
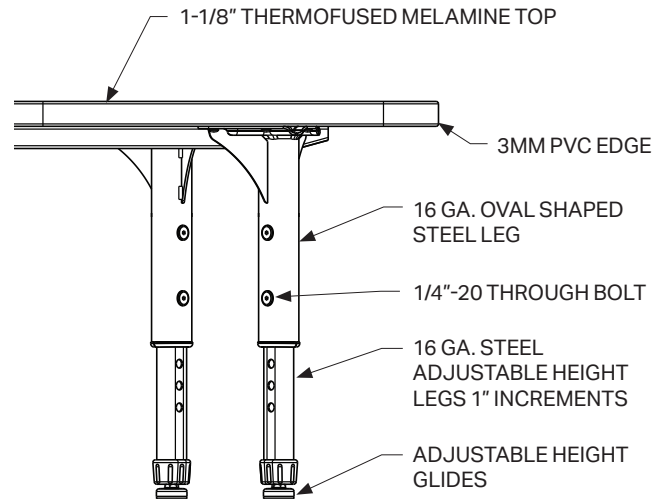

## LEG DETAILS

APEX "C"  
12" - 15"  
TABLE HEIGHT

BASE PLATE:  
12 Ga

BASE TUBE:  
OVAL  
1.38 x 2.19 - 16 Ga

ADJ TUBE:  
OVAL  
1 x 1.5 - 16 Ga

GLIDE:  
ADJUSTABLE

CASTER OPTION

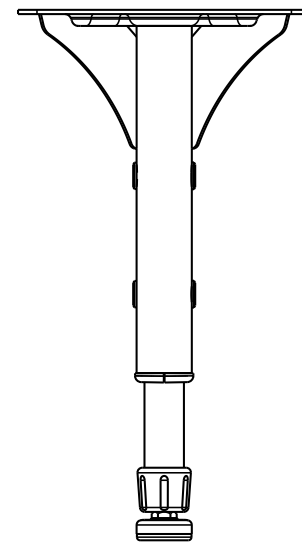

This specification information is provided for general reference only and is subject to change without notice. While every effort has been made to ensure accuracy, Marco makes no warranties, express or implied, regarding the completeness or correctness of the details presented. Users should always verify specifications with the latest product documentation before making any purchasing decisions.

## RECTANGLE TABLES

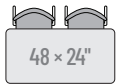

| MODEL        | W   | D   | H       |
|--------------|-----|-----|---------|
| 38-2226-Axxx | 48" | 24" | 32"-42" |
| 38-2226-Bxxx | 48" | 24" | 21"-31" |

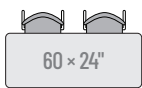

| MODEL        | W   | D   | H       |
|--------------|-----|-----|---------|
| 38-2228-Axxx | 60" | 24" | 32"-42" |
| 38-2228-Bxxx | 60" | 24" | 21"-31" |

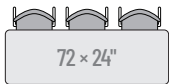

| MODEL        | W   | D   | H       |
|--------------|-----|-----|---------|
| 38-2230-Axxx | 72" | 24" | 32"-42" |
| 38-2230-Bxxx | 72" | 24" | 21"-31" |

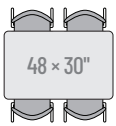

| MODEL        | W   | D   | H       |
|--------------|-----|-----|---------|
| 38-2236-Axxx | 48" | 30" | 32"-42" |
| 38-2236-Bxxx | 48" | 30" | 21"-31" |

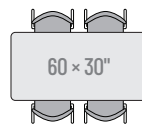

| MODEL        | W   | D   | H       |
|--------------|-----|-----|---------|
| 38-2237-Axxx | 60" | 30" | 32"-42" |
| 38-2237-Bxxx | 60" | 30" | 21"-31" |

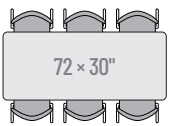

| MODEL        | W   | D   | H       |
|--------------|-----|-----|---------|
| 38-2238-Axxx | 72" | 30" | 32"-42" |
| 38-2238-Bxxx | 72" | 30" | 21"-31" |

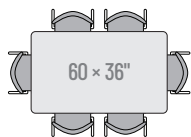

| MODEL        | W   | D   | H       |
|--------------|-----|-----|---------|
| 38-2247-Axxx | 60" | 36" | 32"-42" |
| 38-2247-Bxxx | 60" | 36" | 21"-31" |

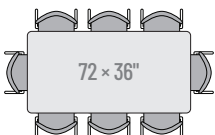

| MODEL        | W   | D   | H       |
|--------------|-----|-----|---------|
| 38-2248-Axxx | 72" | 36" | 32"-42" |
| 38-2248-Bxxx | 72" | 36" | 21"-31" |

## ROUND TABLES



| MODEL        | W   | D   | H       |
|--------------|-----|-----|---------|
| 38-2244-Axxx | 36" | 36" | 32"-42" |
| 38-2244-Bxxx | 36" | 36" | 21"-31" |

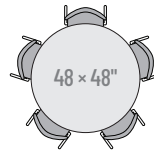

| MODEL        | W   | D   | H       |
|--------------|-----|-----|---------|
| 38-2266-Axxx | 48" | 48" | 32"-42" |
| 38-2266-Bxxx | 48" | 48" | 21"-31" |

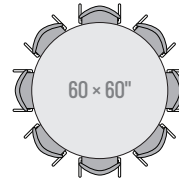

| MODEL        | W   | D   | H       |
|--------------|-----|-----|---------|
| 38-2207-Axxx | 60" | 60" | 32"-42" |
| 38-2207-Bxxx | 60" | 60" | 21"-31" |

## TRAPEZOID TABLES

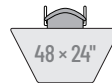

| MODEL        | W   | D   | H       |
|--------------|-----|-----|---------|
| 38-2276-Axxx | 72" | 48" | 32"-42" |
| 38-2276-Bxxx | 72" | 48" | 21"-31" |

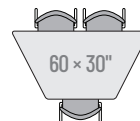

| MODEL        | W   | D   | H       |
|--------------|-----|-----|---------|
| 38-2287-Axxx | 66" | 60" | 32"-42" |
| 38-2287-Bxxx | 66" | 60" | 21"-31" |

## SQUARE TABLE

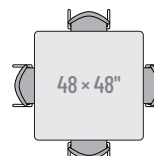

| MODEL        | W   | D   | H       |
|--------------|-----|-----|---------|
| 38-2216-Axxx | 48" | 48" | 32"-42" |
| 38-2216-Bxxx | 48" | 48" | 21"-31" |



### WAVE TABLE

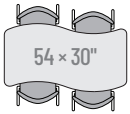

| MODEL        | W   | D   | H       |
|--------------|-----|-----|---------|
| 38-2258-Axxx | 54" | 30" | 32"-42" |
| 38-2258-Bxxx | 54" | 30" | 21"-31" |

### KIDNEY TABLE

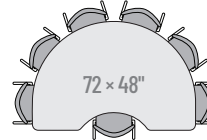

|              |     |     |         |
|--------------|-----|-----|---------|
| 38-2268-Axxx | 72" | 48" | 32"-42" |
| 38-2268-Bxxx | 72" | 48" | 21"-31" |

### HEXAGON TABLE

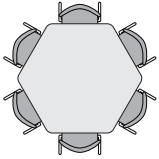

| MODEL        | W     | D   | H       |
|--------------|-------|-----|---------|
| 38-2254-Axxx | 54.5" | 48" | 32"-42" |
| 38-2254-Bxxx | 54.5" | 48" | 21"-31" |

### HORSESHOE TABLE

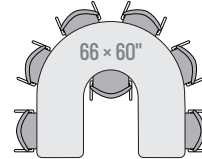

|              |     |     |         |
|--------------|-----|-----|---------|
| 38-2270-Axxx | 66" | 60" | 32"-42" |
| 38-2270-Bxxx | 66" | 60" | 21"-31" |

### WAVE HALF ROUND TABLE

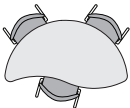

| MODEL        | W   | D   | H       |
|--------------|-----|-----|---------|
| 38-2252-Axxx | 54" | 30" | 32"-42" |
| 38-2252-Bxxx | 54" | 30" | 21"-31" |

### DELTA TABLE

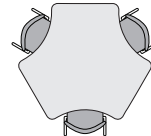

| MODEL        | W   | D   | H       |
|--------------|-----|-----|---------|
| 38-2251-Axxx | 60" | 60" | 32"-42" |
| 38-2251-Bxxx | 60" | 60" | 21"-31" |