

### CONSTRUCTION

- Top constructed of 1 1/8" particleboard with thermo-fused melamine surface on top and bottom
- Thermally fused 3mm PVC edge banding
- Pre-drilled holes for easy leg assembly
- Upper leg constructed of 18-gauge, 1-1/8" round steel welded to 16-gauge steel plate with 1/4" diameter steel wire v-bracing
- Lower adjustable leg constructed of 18-gauge steel with a chrome-plated finish, tapped at 1" intervals for adjustment from (16" - 24") or (21" - 30") leg heights
- 16-gauge 1" square tubular steel stretcher attached to all tables 54" in length or longer
- Adjustable nylon glides allow for easy for leveling

### FINISHES

#### WORKSURFACE LAMINATES

Available with matching edge band except Gray Nebula.



#### DRY ERASE LAMINATES Available with color edge band.

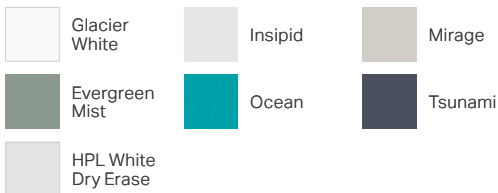

#### OPTIONAL EDGE BAND COLORS

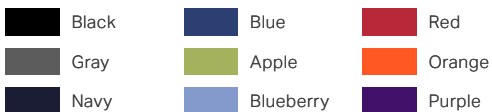

#### METAL LEG OPTIONS



### WARRANTY

10 Year Limited

### CERTIFICATIONS

Worksurfaces are UL Greenguard Gold certified

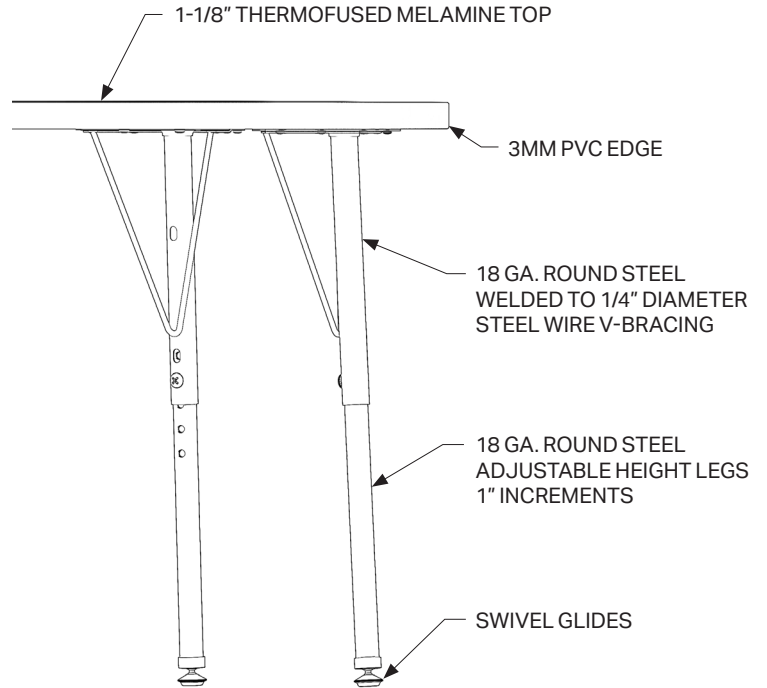

### LEG SIZE OPTIONS

MG "B"  
21" - 30"  
TABLE HEIGHT

BASE PLATE:  
16 Ga

BASE TUBE:  
ROUND  
Ø1.125 - 18 Ga

ADJ TUBE:  
ROUND  
Ø.98 - 18 Ga

LEG BRACKET:  
14 Ga

GLIDE:  
SWIVEL

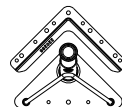

MG "B"

MG "A"  
16" - 24"  
TABLE HEIGHT

BASE PLATE:  
16 Ga

BASE TUBE:  
ROUND  
Ø1.125 - 18 Ga

ADJ TUBE:  
ROUND  
Ø.98 - 18 Ga

LEG BRACKET:  
14 Ga

GLIDE:  
SWIVEL

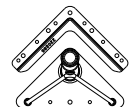

MG "A"

This specification information is provided for general reference only and is subject to change without notice. While every effort has been made to ensure accuracy, Marco makes no warranties, express or implied, regarding the completeness or correctness of the details presented. Users should always verify specifications with the latest product documentation before making any purchasing decisions.

### RECTANGLE TABLES

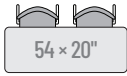

MODEL	W	D	H
MG2221-Axxx	54"	20"	32"-42"
MG2221-Bxxx	54"	20"	21"-31"



MG2222-Axxx	60"	20"	32"-42"
MG2222-Bxxx	60"	20"	21"-31"

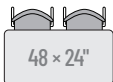

MG2226-Axxx	48"	24"	32"-42"
MG2226-Bxxx	48"	24"	21"-31"



MG2225-Axxx	54"	24"	32"-42"
MG2225-Bxxx	54"	24"	21"-31"

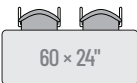

MG2228-Axxx	60"	24"	32"-42"
MG2228-Bxxx	60"	24"	21"-31"

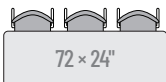

MG2230-Axxx	72"	24"	32"-42"
MG2230-Bxxx	72"	24"	21"-31"

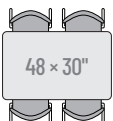

MG2236-Axxx	48"	30"	32"-42"
MG2236-Bxxx	48"	30"	21"-31"

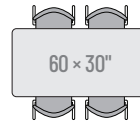

MODEL	W	D	H
MG2237-Axxx	60"	30"	32"-42"
MG2237-Bxxx	60"	30"	21"-31"

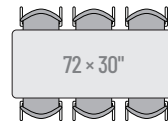

MG2238-Axxx	72"	30"	32"-42"
MG2238-Bxxx	72"	30"	21"-31"

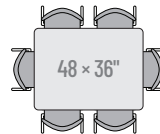

MG2246-Axxx	48"	36"	32"-42"
MG2246-Bxxx	48"	36"	21"-31"

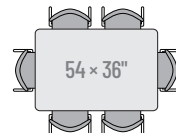

MG2249-Axxx	54"	36"	32"-42"
MG2249-Bxxx	54"	36"	21"-31"

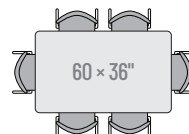

MG2247-Axxx	60"	36"	32"-42"
MG2247-Bxxx	60"	36"	21"-31"

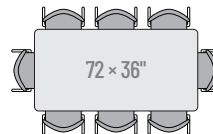

MG2248-Axxx	72"	36"	32"-42"
MG2248-Bxxx	72"	36"	21"-31"

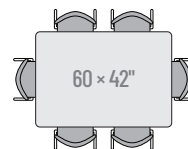

MG2250-Axxx	60"	42"	32"-42"
MG2250-Bxxx	60"	42"	21"-31"

### ROUND TABLES



MODEL	W	D	H
MG2244-Axxx	36"	36"	32"-42"
MG2244-Bxxx	36"	36"	21"-31"

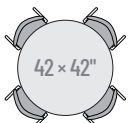

MG2245-Axxx	42"	42"	32"-42"
MG2245-Bxxx	42"	42"	21"-31"

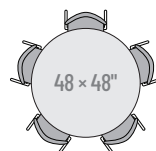

MODEL	W	D	H
MG2266-Axxx	48"	48"	32"-42"
MG2266-Bxxx	48"	48"	21"-31"

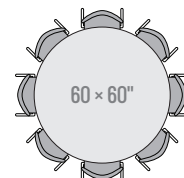

MG2207-Axxx	60"	60"	32"-42"
MG2207-Bxxx	60"	60"	21"-31"

### SQUARE TABLES

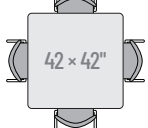
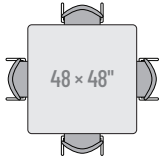
	MODEL	W	D	H
	MG2212-Axxx	36"	36"	32"-42"
	MG2212-Bxxx	36"	36"	21"-31"
	MG2214-Axxx	42"	42"	32"-42"
	MG2214-Bxxx	42"	42"	21"-31"
	MG2216-Axxx	48"	48"	32"-42"
	MG2216-Bxxx	48"	48"	21"-31"

### WAVE TABLES

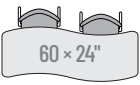
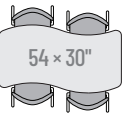
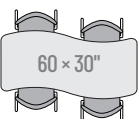
	MODEL	W	D	H
	MG2257-Axxx	60"	24"	32"-42"
	MG2257-Bxxx	60"	24"	21"-31"
	MG2258-Axxx	54"	30"	32"-42"
	MG2258-Bxxx	54"	30"	21"-31"
	MG2259-Axxx	60"	30"	32"-42"
	MG2259-Bxxx	60"	30"	21"-31"

### HALF ROUND TABLES

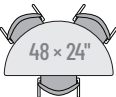
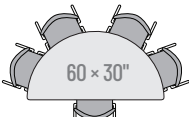
	MODEL	W	D	H
	MG2277-Axxx	48"	24"	32"-42"
	MG2277-Bxxx	48"	24"	21"-31"
	MG2278-Axxx	60"	30"	32"-42"
	MG2278-Bxxx	60"	30"	21"-31"

### KIDNEY TABLES

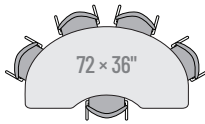
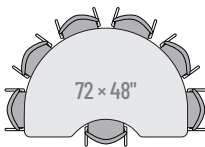
	MODEL	W	D	H
	MG2267-Axxx	72"	36"	32"-42"
	MG2267-Bxxx	72"	36"	21"-31"
	MG2268-Axxx	72"	48"	32"-42"
	MG2268-Bxxx	72"	48"	21"-31"

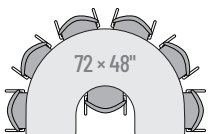
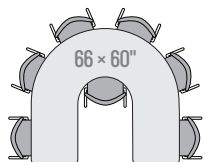

### HORSESHOE TABLES

	MODEL	W	D	H
	MG2227-Axxx	72"	48"	32"-42"
	MG2227-Bxxx	72"	48"	21"-31"
	MG2270-Axxx	66"	60"	32"-42"
	MG2270-Bxxx	66"	60"	21"-31"

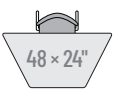
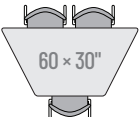
### TRAPEZOID TABLES

	MODEL	W	D	H
	MG2276-Axxx	72"	48"	32"-42"
	MG2276-Bxxx	72"	48"	21"-31"
	MG2287-Axxx	66"	60"	32"-42"
	MG2287-Bxxx	66"	60"	21"-31"

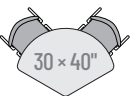
### SECTION TABLES

	MODEL	W	D	H
	MG2294-Axxx	30"	40"	32"-42"
	MG2294-Bxxx	30"	40"	21"-31"
	MG2295-Axxx	35"	50"	32"-42"
	MG2295-Bxxx	35"	50"	21"-31"

### 5-STAR TABLES

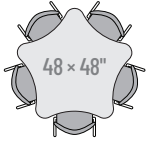

MODEL	W	D	H
MG2280-Axxx	48"	48"	32"-42"
MG2280-Bxxx	48"	48"	21"-31"

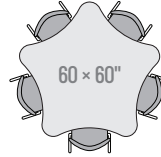

MODEL	W	D	H
MG2281-Axxx	60"	60"	32"-42"
MG2281-Bxxx	60"	60"	21"-31"

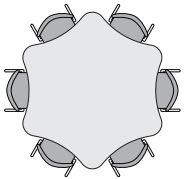

### 6-STAR TABLE

MODEL	W	D	H
MG2282-Axxx	60"	60"	32"-42"
MG2282-Bxxx	60"	60"	21"-31"

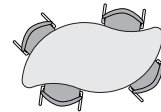

### VEER TABLE

MODEL	W	D	H
MG2255-Axxx	60"	30"	32"-42"
MG2255-Bxxx	60"	30"	21"-31"

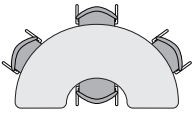

### HALF MOON TABLE

MODEL	W	D	H
MG2279-Axxx	72"	36"	32"-42"
MG2279-Bxxx	72"	36"	21"-31"

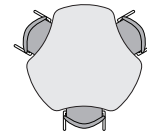

### TRIAD TABLE

MODEL	W	D	H
MG2264-Axxx	48"	48"	32"-42"
MG2264-Bxxx	48"	48"	21"-31"

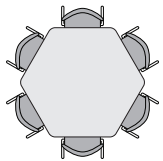

### HEXAGON TABLE

MODEL	W	D	H
MG2254-Axxx	54.5"	48"	32"-42"
MG2254-Bxxx	54.5"	48"	21"-31"

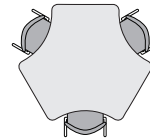

### DELTA TABLE

MODEL	W	D	H
MG2251-Axxx	60"	60"	32"-42"
MG2251-Bxxx	60"	60"	21"-31"

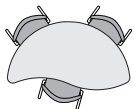

### WAVE HALF ROUND TABLE

MODEL	W	D	H
MG2252-Axxx	54"	30"	32"-42"
MG2252-Bxxx	54"	30"	21"-31"

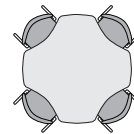

### CLOVER TABLE

MODEL	W	D	H
MG2265-Axxx	48"	48"	32"-42"
MG2265-Bxxx	48"	48"	21"-31"

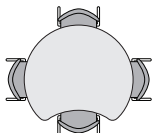

### SCOOP TABLE

MODEL	W	D	H
MG2296-Axxx	48"	38"	32"-42"
MG2296-Bxxx	48"	38"	21"-31"

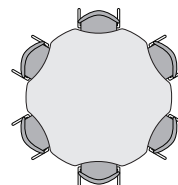

### FLOWER TABLE

MODEL	W	D	H
MG2208-Axxx	60"	60"	32"-42"
MG2208-Bxxx	60"	60"	21"-31"