

CONSTRUCTION

- Top constructed of 1 1/8" particleboard with thermo-fused melamine surface on top and bottom
- Thermally fused 3mm PVC edge banding
- Pre-drilled holes for easy leg assembly
- Upper leg constructed of 16-gauge, 2" round steel mounted on a 12-gauge steel plate, fully coated with a durable powder coat finish
- Lower adjustable leg constructed of 16-gauge steel with a chrome-plated finish, tapped at 1" intervals for adjustment from (21" - 31") leg heights or (32" - 42") leg heights with select models
- Adjustable nylon glides allow for easy for leveling

FINISHES

WORKSURFACE LAMINATES

Available with matching edge band except Gray Nebula.



DRY ERASE LAMINATES Available with color edge band.

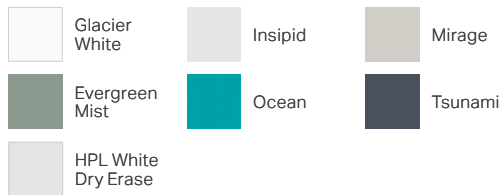

OPTIONAL EDGE BAND COLORS

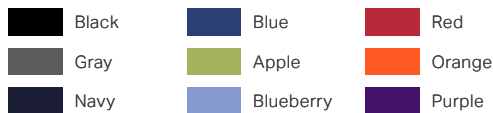

METAL LEG OPTIONS



WARRANTY

10 Year Limited

CERTIFICATIONS

Worksurfaces are UL Greenguard Gold certified

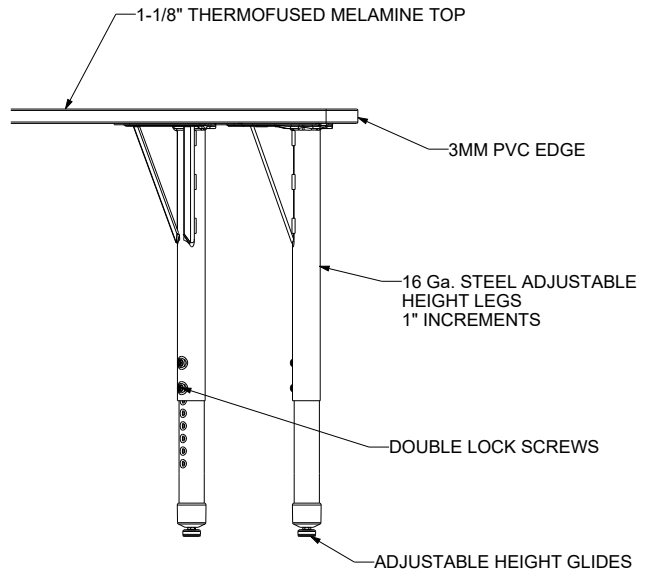

LEG SIZE OPTIONS

NOTE: "A" LEG ONLY AVAILABLE ON SELECT DESK MODELS.

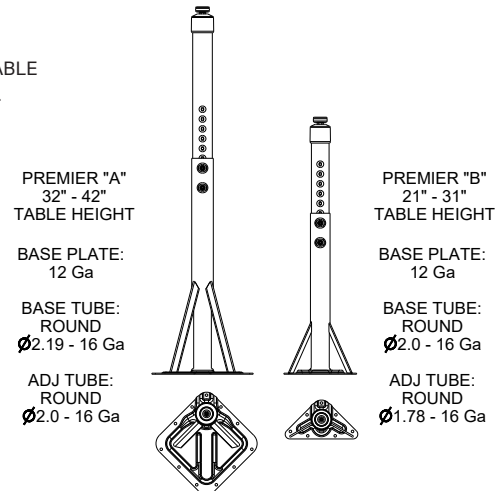

ACCESSORIES

| Model # | Description |
|-------------|---|
| 98-1006 | Plastic Book Box (20" x 4" x 14.5")* |
| 98-1014 | 2-Sided Plastic Book Box* |
| 98-1029-BLK | Wire Book Basket (16.75" x 4" x 15.25")* |
| 98-1016 | 2.5" Locking Casters (set of 2) |
| 98-1013 | Makerspace Tray Mount Kit (tray sold separately)* |
| 98-1004 | Backpack Hook |

* ACCESSORY MAY NOT FIT SELECT DESKS WITH "A" LEG.
See individual model information on next page for more details.

This specification information is provided for general reference only and is subject to change without notice. While every effort has been made to ensure accuracy, Marco makes no warranties, express or implied, regarding the completeness or correctness of the details presented. Users should always verify specifications with the latest product documentation before making any purchasing decisions.



MARCO™

Specification Sheet

PREMIER® SERIES

Collaborative Desks

RECTANGLE DESK

| MODEL | W | D | H |
|--------------|-----|-----|---------|
| 43-2223-Axxx | 30" | 20" | 32"-42" |
| 43-2223-Bxxx | 30" | 20" | 21"-31" |

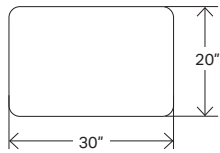

Note: Book boxes, wire basket or tray mount kit will not fit with "A" leg model.

RECTANGLE DESK

| MODEL | W | D | H |
|--------------|-----|-----|---------|
| 43-2220-Axxx | 36" | 20" | 32"-42" |
| 43-2220-Bxxx | 36" | 20" | 21"-31" |

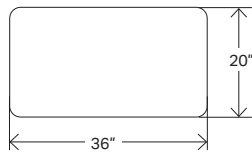

Note: Book boxes will not fit with "A" leg model.

RECTANGLE DESK

| MODEL | W | D | H |
|--------------|-----|-----|---------|
| 43-2229-Axxx | 30" | 24" | 32"-42" |
| 43-2229-Bxxx | 30" | 24" | 21"-31" |

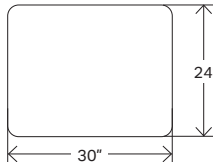

Note: Book boxes, wire basket or tray mount kit will not fit with "A" leg model.

RECTANGLE DESK

| MODEL | W | D | H |
|--------------|-----|-----|---------|
| 43-2224-Axxx | 36" | 24" | 32"-42" |
| 43-2224-Bxxx | 36" | 24" | 21"-31" |

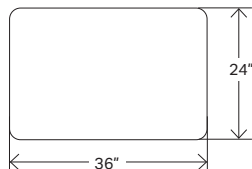

Note: Book boxes will not fit with "A" leg model.

GEM DESK

| MODEL | W | D | H |
|--------------|--------|-------|---------|
| 43-2271-Axxx | 29.75" | 33.5" | 32"-42" |
| 43-2271-Bxxx | 29.75" | 33.5" | 21"-31" |

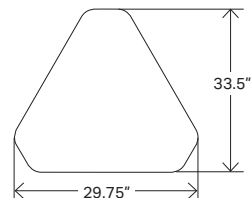

Note: Book boxes, wire basket or tray mount kit will not fit with "A" leg model.

TRIANGLE DESK

| MODEL | W | D | H |
|--------------|-----|-----|---------|
| 43-2272-Bxxx | 41" | 23" | 21"-31" |

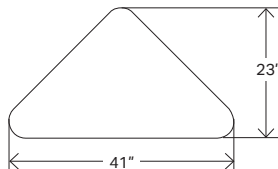

CHEVRON DESK

| MODEL | W | D | H |
|--------------|-----|-----|---------|
| 43-2292-Bxxx | 30" | 25" | 21"-31" |

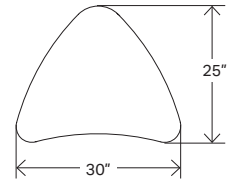

CHEVRON DESK

| MODEL | W | D | H |
|--------------|-----|-----|---------|
| 43-2290-Bxxx | 38" | 31" | 21"-31" |

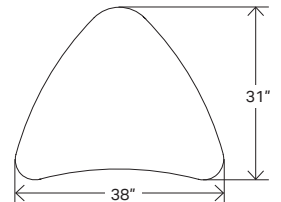

TRAPEZOID DESK

| MODEL | W | D | H |
|--------------|-----|-----|---------|
| 43-2285-Bxxx | 32" | 22" | 21"-31" |

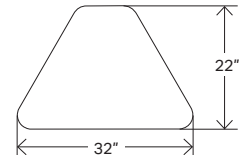

TRAPEZOID DESK

| MODEL | W | D | H |
|--------------|-----|-----|---------|
| 43-2283-Bxxx | 31" | 20" | 21"-31" |

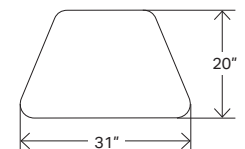

TRAPEZOID DESK

| MODEL | W | D | H |
|--------------|-----|-----|---------|
| 43-2284-Bxxx | 36" | 23" | 21"-31" |

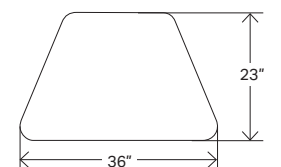

CURVE DESK

| MODEL | W | D | H |
|--------------|-----|-----|---------|
| 43-2291-Bxxx | 28" | 24" | 21"-31" |

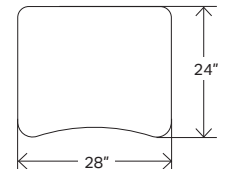

FLARE DESK

| MODEL | W | D | H |
|--------------|-----|-----|---------|
| 43-2274-Axxx | 30" | 24" | 32"-42" |
| 43-2274-Bxxx | 30" | 24" | 21"-31" |

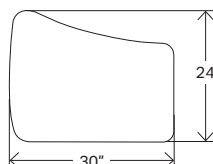

Note: Book boxes, wire basket or tray mount kit will not fit with "A" leg model.

CONTOUR DESK

| MODEL | W | D | H |
|--------------|-----|-----|---------|
| 43-2310-Axxx | 28" | 24" | 32"-42" |
| 43-2310-Bxxx | 28" | 24" | 21"-31" |

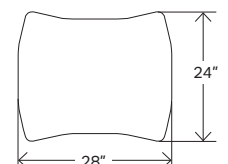

Note: Book boxes, wire basket or tray mount kit will not fit with "A" leg model.