

CONSTRUCTION

- Top constructed of 1 1/8" particleboard with thermo-fused melamine surface on top and bottom
- Thermally fused 3mm PVC edge banding
- Pre-drilled holes for easy leg assembly
- Upper leg constructed of 16-gauge, 2" round steel mounted on a 12-gauge steel plate, fully coated with a durable powder coat finish
- Lower adjustable leg constructed of 16-gauge steel with a chrome-plated finish, tapped at 1" intervals for adjustment from (21" - 31") leg heights or (32" - 42") leg heights with select models
- Adjustable nylon glides allow for easy for leveling

FINISHES

WORKSURFACE LAMINATES

Available with matching edge band except Gray Nebula.



DRY ERASE LAMINATES Available with color edge band.

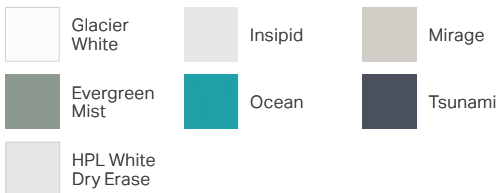

OPTIONAL EDGE BAND COLORS

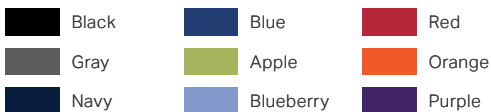

METAL LEG OPTIONS



WARRANTY

10 Year Limited

CERTIFICATIONS

Worksurfaces are UL Greenguard Gold certified

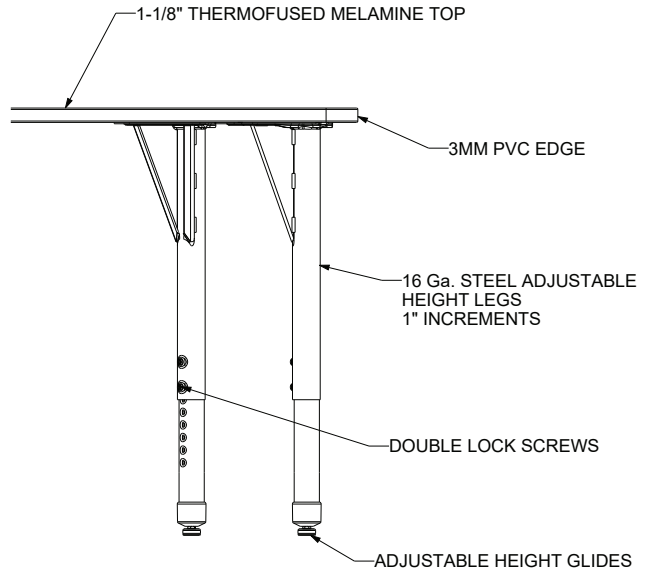

LEG SIZE OPTIONS

NOTE: "A" LEG ONLY AVAILABLE ON SELECT DESK MODELS.

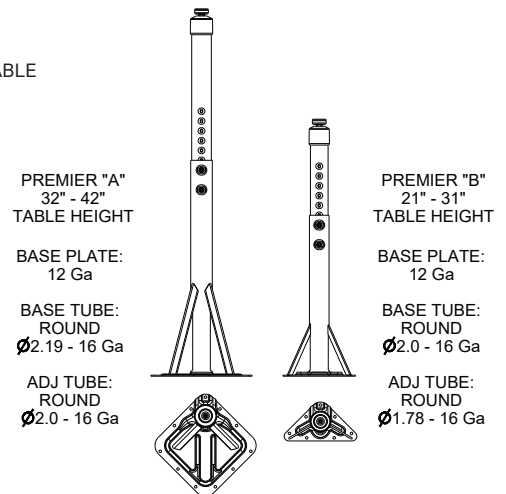

ACCESSORIES

Model #	Description
98-1006	Plastic Book Box (20"x 4"x 14.5")*
98-1014	2-Sided Plastic Book Box*
98-1029-BLK	Wire Book Basket (16.75"x 4"x 15.25")*
98-1016	2.5" Locking Casters (set of 2)
98-1013	Makerspace Tray Mount Kit (tray sold separately)*
98-1004	Backpack Hook

* ACCESSORY MAY NOT FIT SELECT DESKS WITH "A" LEG.
See individual model information on next page for more details.

This specification information is provided for general reference only and is subject to change without notice. While every effort has been made to ensure accuracy, Marco makes no warranties, express or implied, regarding the completeness or correctness of the details presented. Users should always verify specifications with the latest product documentation before making any purchasing decisions.



MARCO™

Specification Sheet

PREMIER® SERIES

Collaborative Desks

RECTANGLE DESK

MODEL	W	D	H
43-2223-Axxx	30"	20"	32"-42"
43-2223-Bxxx	30"	20"	21"-31"

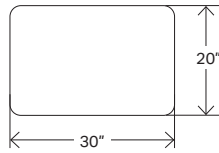

Note: Book boxes, wire basket or tray mount kit will not fit with "A" leg model.

CHEVRON DESK

MODEL	W	D	H
43-2292-Bxxx	30"	25"	21"-31"

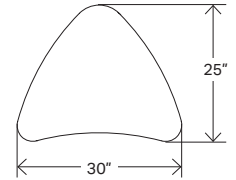

RECTANGLE DESK

MODEL	W	D	H
43-2220-Axxx	36"	20"	32"-42"
43-2220-Bxxx	36"	20"	21"-31"

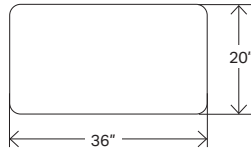

Note: Book boxes will not fit with "A" leg model.

CHEVRON DESK

MODEL	W	D	H
43-2290-Bxxx	38"	31"	21"-31"

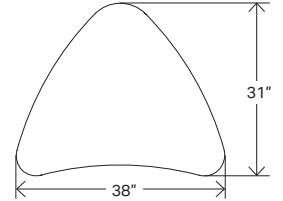

RECTANGLE DESK

MODEL	W	D	H
43-2229-Axxx	30"	24"	32"-42"
43-2229-Bxxx	30"	24"	21"-31"

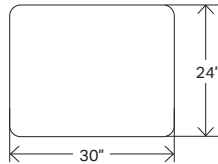

Note: Book boxes, wire basket or tray mount kit will not fit with "A" leg model.

TRAPEZOID DESK

MODEL	W	D	H
43-2285-Bxxx	32"	22"	21"-31"

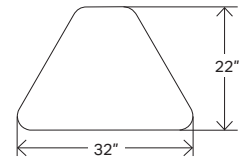

RECTANGLE DESK

MODEL	W	D	H
43-2224-Axxx	36"	24"	32"-42"
43-2224-Bxxx	36"	24"	21"-31"

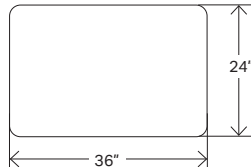

Note: Book boxes will not fit with "A" leg model.

TRAPEZOID DESK

MODEL	W	D	H
43-2283-Bxxx	31"	20"	21"-31"

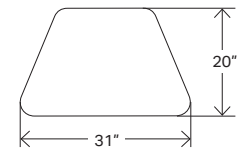

GEM DESK

MODEL	W	D	H
43-2271-Axxx	29.75"	33.5"	32"-42"
43-2271-Bxxx	29.75"	33.5"	21"-31"

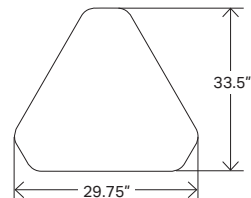

Note: Book boxes, wire basket or tray mount kit will not fit with "A" leg model.

TRAPEZOID DESK

MODEL	W	D	H
43-2284-Bxxx	36"	23"	21"-31"

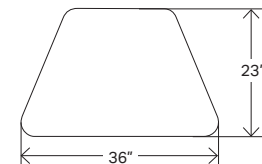

TRIANGLE DESK

MODEL	W	D	H
43-2272-Bxxx	40"	23"	21"-31"

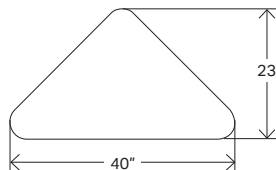

CURVE DESK

MODEL	W	D	H
43-2291-Bxxx	28"	24"	21"-31"

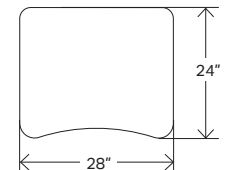

FLARE DESK

MODEL	W	D	H
43-2274-Axxx	30"	24"	32"-42"
43-2274-Bxxx	30"	24"	21"-31"

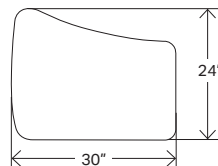

Note: Book boxes, wire basket or tray mount kit will not fit with "A" leg model.

CONTOUR DESK

MODEL	W	D	H
43-2310-Axxx	28"	24"	32"-42"
43-2310-Bxxx	28"	24"	21"-31"

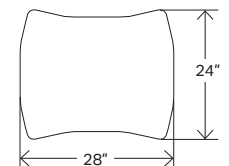

Note: Book boxes, wire basket or tray mount kit will not fit with "A" leg model.